

TECHNICAL DRAWING

PRODUCT	50ml Amber Reagent Bottle
PRODUCT CODE	10040

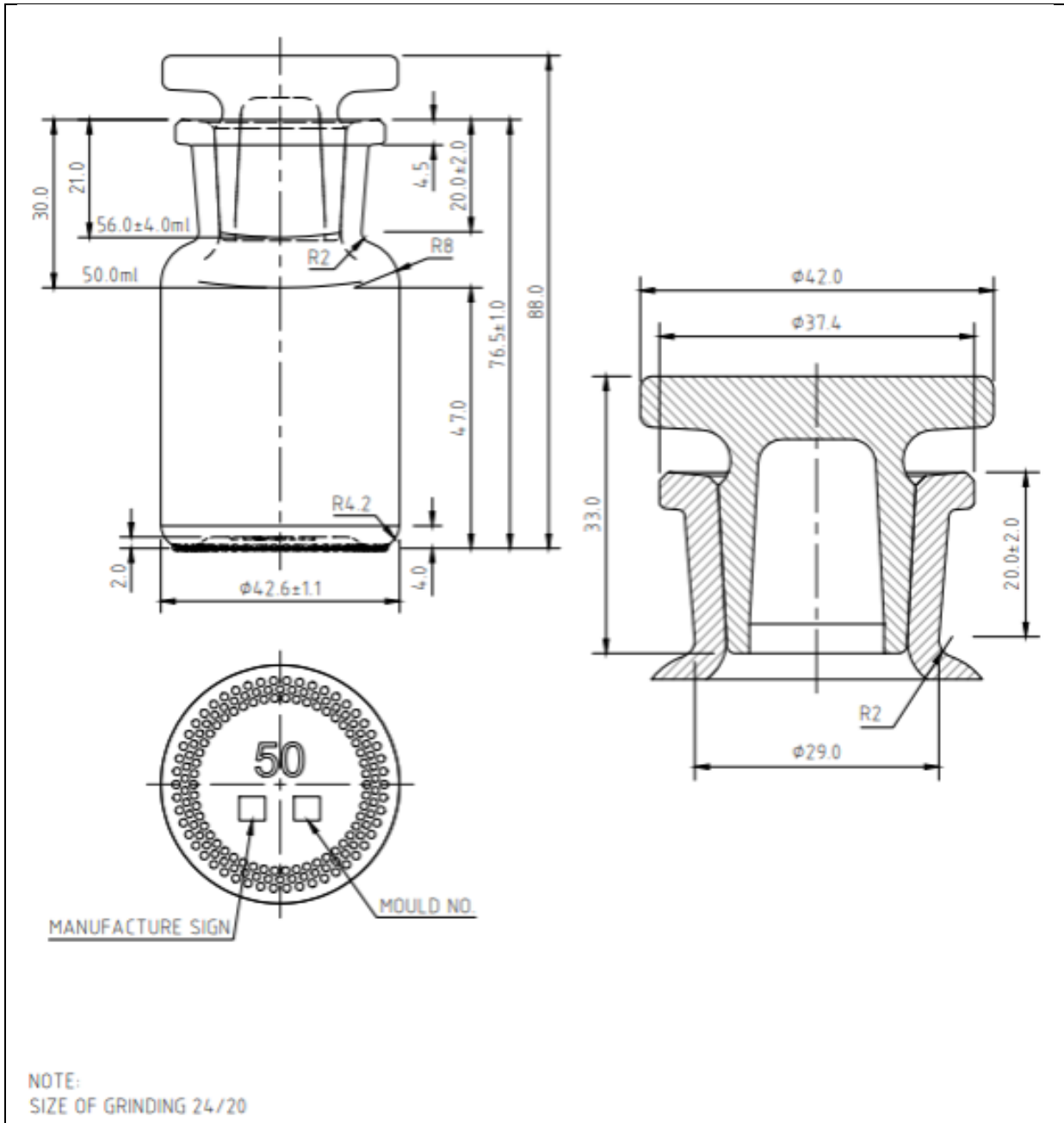

PRODUCT SPECIFICATION DETAILS:

Date of Drawing	21/05/20
Scale	Not to scale
Glass Weight (g)	100g
Additional Information	Brimful Capacity 56±4ml
Material recyclable?	Yes (check with local waste collection provider)