

TECHNICAL DRAWING

PRODUCT	250ml Amber Reagent Bottle
PRODUCT CODE	10042

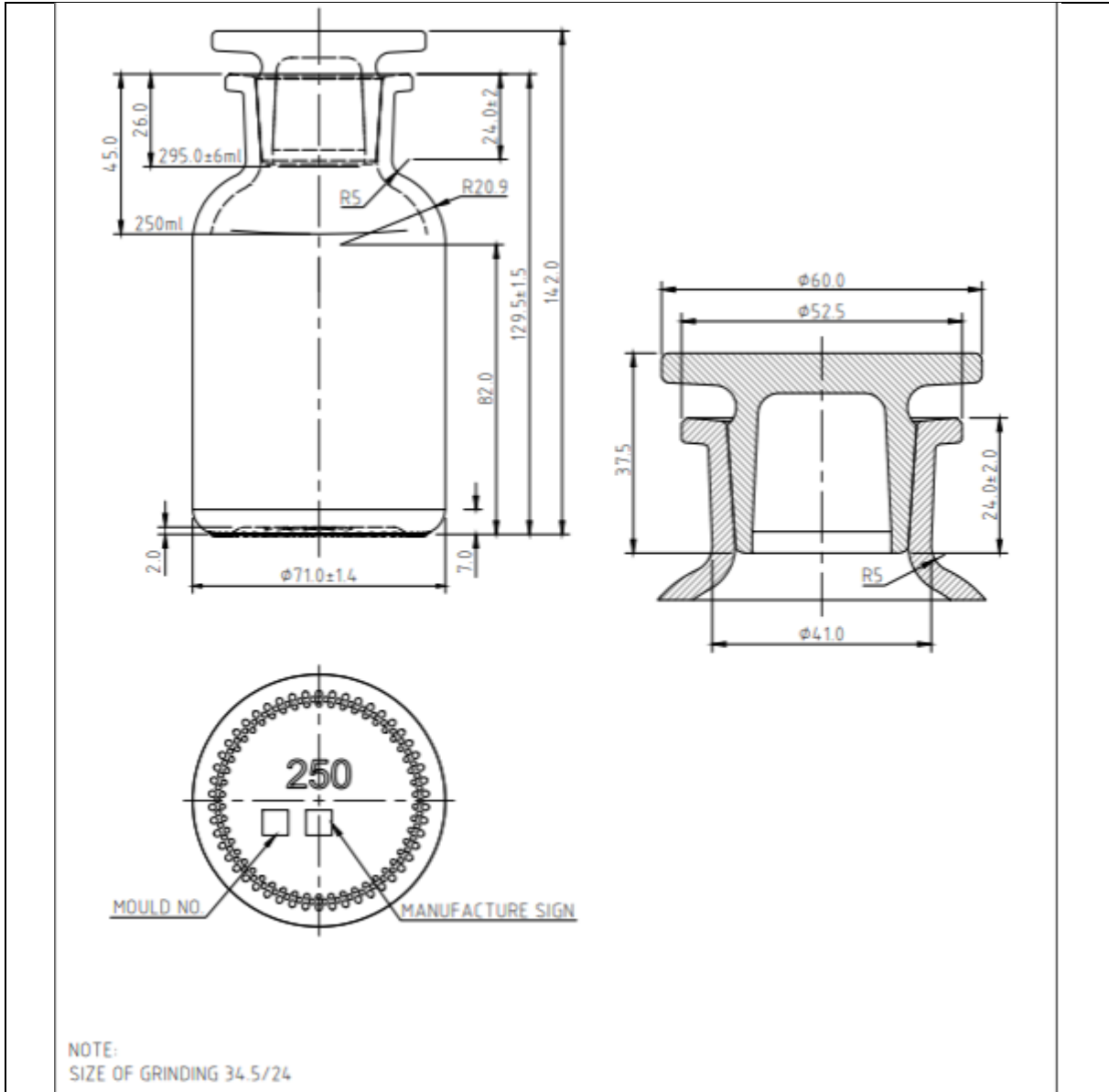

PRODUCT SPECIFICATION DETAILS:

Date of Drawing	21/05/20
Scale	Not to scale
Glass Weight (g)	320g
Additional Information	Brimful Capacity 295±6ml
Material recyclable?	Yes (check with local waste collection provider)