

TECHNICAL DRAWING

PRODUCT	100ml Clear Reagent Bottle
PRODUCT CODE	10037

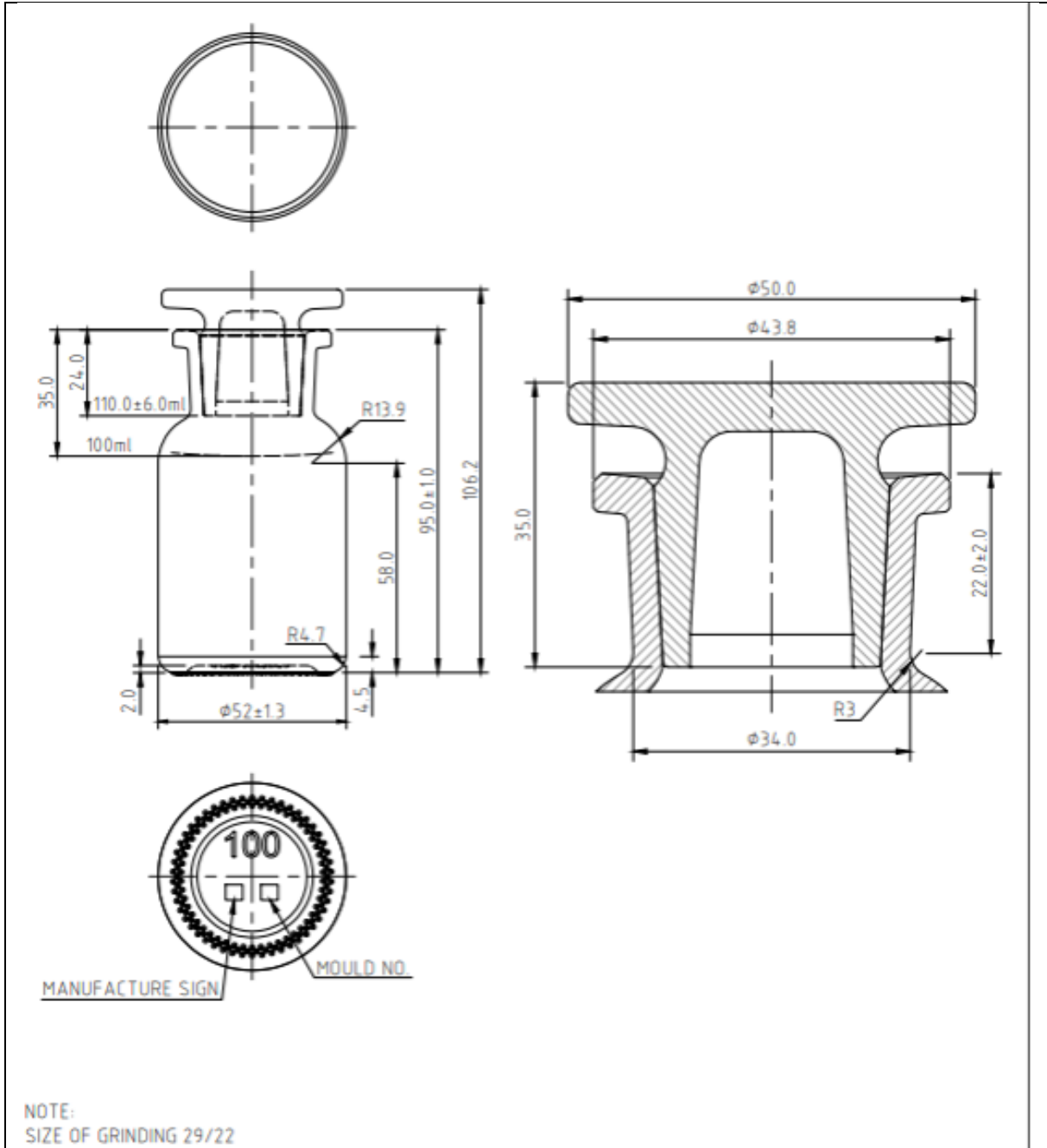

PRODUCT SPECIFICATION DETAILS:

Date of Drawing	20/09/20
Scale	Not to scale
Glass Weight (g)	165g
Additional Information	Brimful Capacity 110±6ml
Material recyclable?	Yes (check with local waste collection provider)